

M81705FP

HIGH VOLTAGE HIGH SIDE DRIVER

DESCRIPTION

M81705FP is high voltage Power MOSFET and IGBT module driver for half bridge applications.

FEATURES

- FLOATING SUPPLY VOLTAGE 600V
- OUTPUT CURRENT +150mA
-125mA
- HIGH SIDE DRIVER
- SOP-8

APPLICATIONS

PDP, MOSFET and IGBT module inverter driver for AC-servomotor and general purpose.

PIN CONFIGURATION (TOP VIEW)

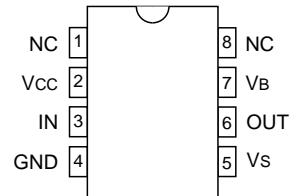

NC:NO INTERNAL CONNECTION

Outline 8P2S

BLOCK DIAGRAM

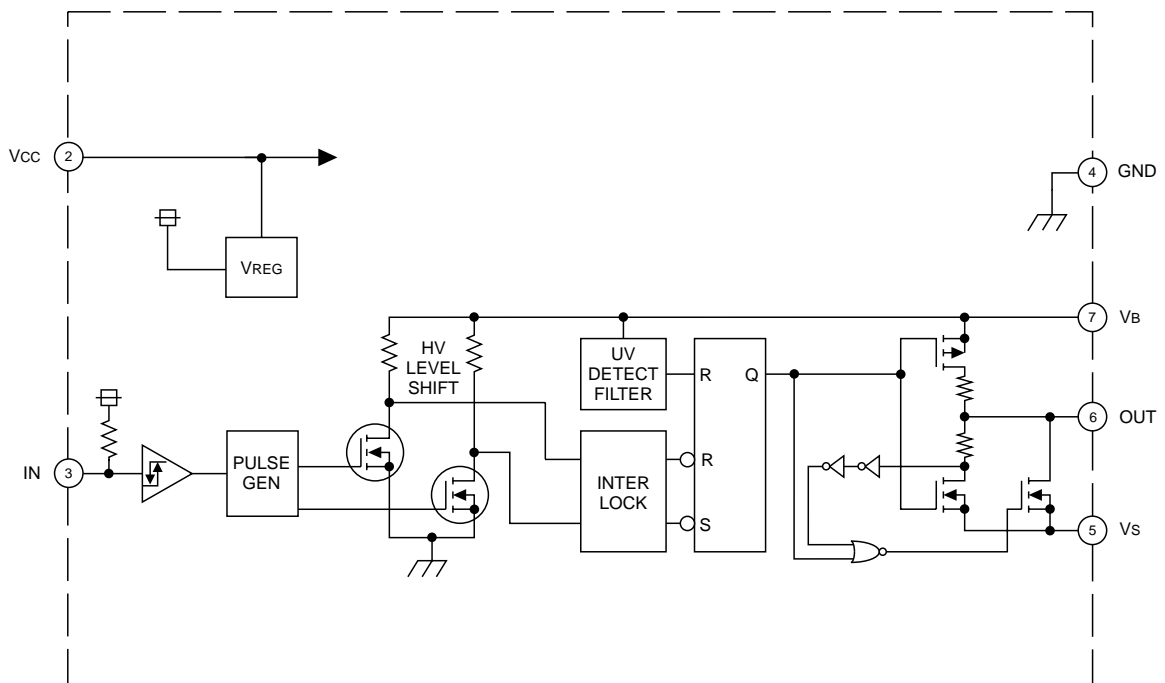

ABSOLUTE MAXIMUM RATINGS

Symbol	Parameter	Conditions	Ratings	Unit
V _B	High Side Floating Supply Absolute Voltage		-0.5 ~ 624	V
V _S	High Side Floating Supply Offset Voltage		V _B -24 ~ V _B +0.5	V
V _{BS}	High Side Floating Supply Voltage	V _{BS} = V _B -V _S	-0.5 ~ 24	V
V _{OUT}	High Side Output Voltage		V _S -0.5 ~ V _B +0.5	V
V _{CC}	Low Side Fixed Supply Voltage		-0.5 ~ 24	V
V _{IN}	Logic Input Voltage		-0.5 ~ 5.5	V
dV _S /dt	Allowable Offset Supply Voltage Transient		±50	V/ns
P _D	Package Power Dissipation	T _a = 25°C, On Board	0.60	W
K _θ	Linear Derating Factor	T _a > 25°C, On Board	-6.0	mW/°C
R _{th(j-c)}	Junction-Case Thermal Resistance		50	°C/W
T _j	Junction Temperature		-20 ~ 125	°C
T _{opr}	Operation Temperature		-20 ~ 100	°C
T _{stg}	Storage Temperature		-40 ~ 125	°C

RECOMMENDED OPERATING CONDITIONS

Symbol	Parameter	Test conditions	Limits			Unit
			Min.	Typ.	Max.	
V _B	High Side Floating Supply Absolute Voltage		V _S +13.5	—	V _S +20	V
V _S	High Side Floating Supply Offset Voltage	V _B > 13.5V	-5	—	500	V
V _{BS}	High Side Floating Supply Voltage	V _{BS} = V _B -V _S	13.5	—	20	V
V _{CC}	Low Side Fixed Supply Voltage		13.5	—	20	V
V _{IN}	Logic Input Voltage		0	—	5	V

THERMAL DERATING FACTOR CHARACTERISTIC

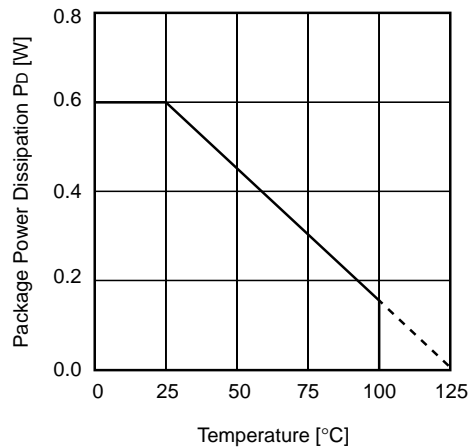

ELECTRICAL CHARACTERISTICS (Ta=25°C, Vcc=Vbs (=Vb-Vs)=15V, unless otherwise specified)

Symbol	Parameter	Test conditions	Limits			Unit
			Min.	Typ.*	Max.	
IFS	Floating Supply Leakage Current	Vb=Vs=600V	—	—	1.0	μA
IBS	Vbs Standby Current		0.25	0.50	0.75	mA
ICC	Vcc Standby Current		0.50	0.75	1.00	mA
VOH	High Level Output Voltage	IO=0A	14.9	—	—	V
VOL	Low Level Output Voltage	IO=0A	—	—	0.1	V
VIH	High Level Input Threshold Voltage		2.5	3.0	4.0	V
VIL	Low Level Input Threshold Voltage		0.8	1.5	2.0	V
IiH	High Level Input Bias Current	VIN=5V	-50	-20	—	μA
IiL	Low Level Input Bias Current	VIN=0V	-200	-100	—	μA
VBSuvr	Vbs Supply UV Reset Voltage		10.5	11.5	12.5	V
VBSuvh	Vbs Supply UV Hysteresis Voltage		0.2	0.5	0.8	V
tVBSuv	Vbs Supply UV Filter Time		—	5	—	μs
IOH	Output High Level Short Circuit Pulsed Current	VO=0V, VIN=0V, PW<10μs	—	-125	—	mA
IOL1	Output Low Level Short Circuit Pulsed Current	VO=1V, VIN=5V, PW<10μs	—	40	—	mA
IOL2	Output Low Level Short Circuit Pulsed Current	VO=15V, VIN=5V, PW<10μs	—	150	—	mA
ROH	Output High Level On Resistance	IO=-100mA, ROH=(VOH-VO)/IO	—	120	160	Ω
ROL1	Output Low Level On Resistance1	VO=1V, ROL1=VO/IO	—	50	60	Ω
ROL2	Output Low Level On Resistance2	VO=5V, ROL2=VO/IO	—	100	130	Ω
tdLH	High Side Turn-On Propagation Delay	CL=1000pF between OUT – Vs	100	—	500	ns
tdHL	High Side Turn-Off Propagation Delay	CL=1000pF between OUT – Vs	100	—	500	ns
tr	High Side Turn-On Rise Time	CL=1000pF between OUT – Vs	—	220	—	ns
tf	High Side Turn-Off Fall Time	CL=1000pF between OUT – Vs	—	110	—	ns
VOth	ROL1/ROL2 Switching Output Voltage		1.5	2.5	4.0	V

* Typ. is not specified.

TIMING DIAGRAM

1. Input/Output Timing Diagram

When input signal is "L", then output signal "H".

2. VBS Supply Under Voltage Lockout Timing Diagram

When VBS Supply Voltage keeps lower UV Trip Voltage ($V_{BSUVt} = V_{BSUVr} - V_{BSUVh}$) for VBS Supply UV Filter Time, output signal becomes "L". And then, VBS Supply Voltage is higher UV Reset Voltage, output signal keeps "L" until next input signal is "L".

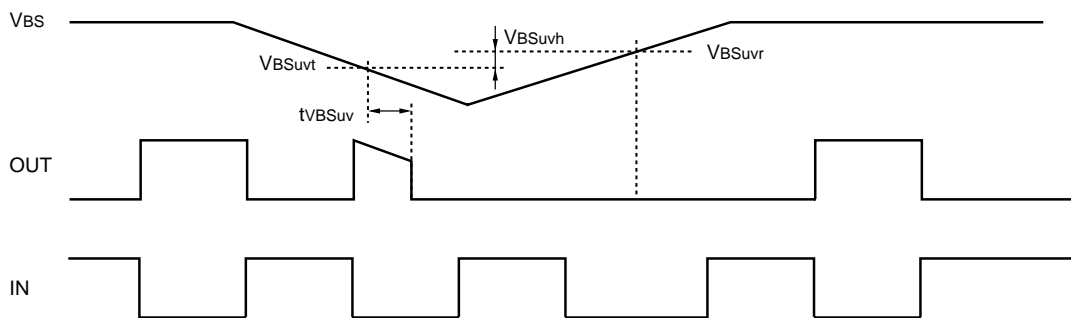

3. Allowable supply voltage transient

Firstly, supply VCC with voltage. Secondly, supply VBS with voltage. In the case of shutting off supply voltage, shut off VBS Supply Voltage firstly. Secondly, shut off VCC Supply Voltage.

In case VBS or VCC is started too fast, output signal may be "H".

4. ROL1/ROL2 Switching Output Voltage V_{Oth}

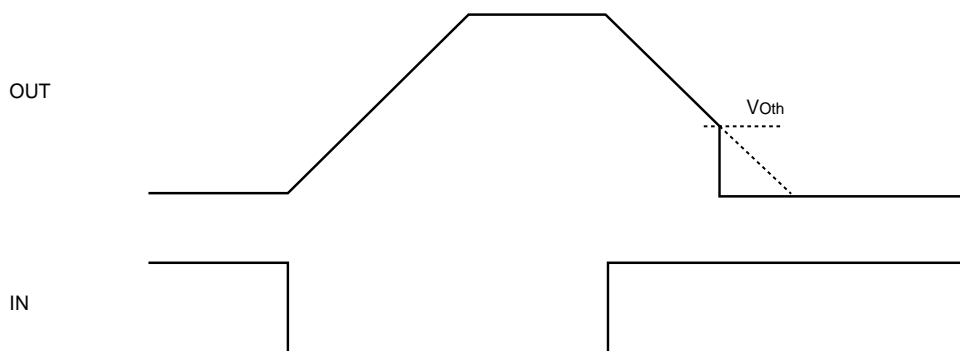

As shown by the solid line of the timing chart, the output on-resistance drops at ' V_{Oth} ' level when the output is in the 'L' state (output level falls). Below the ' V_{Oth} ' level, the output level falls more steeply.

PERFORMANCE CURVES

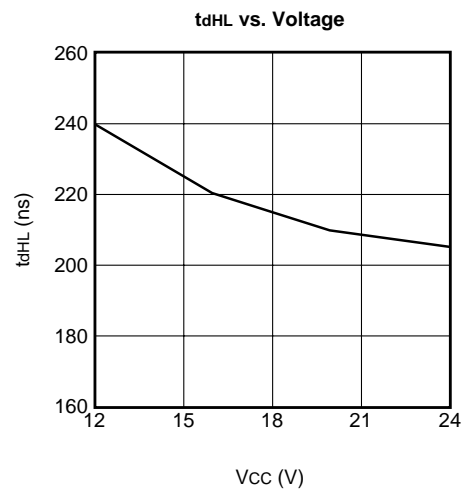
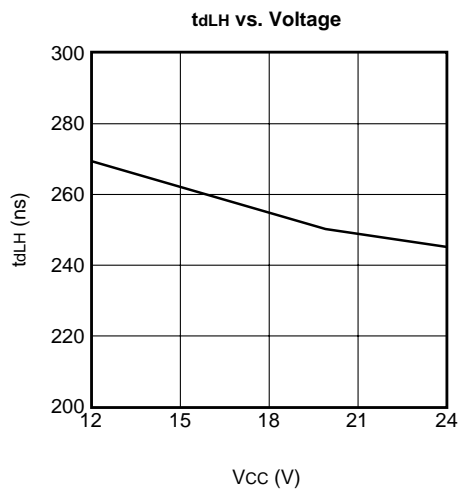
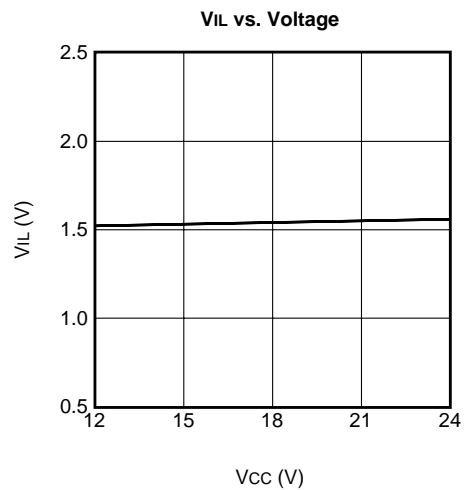
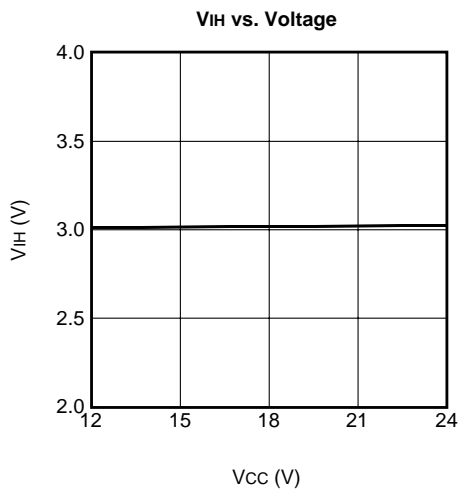
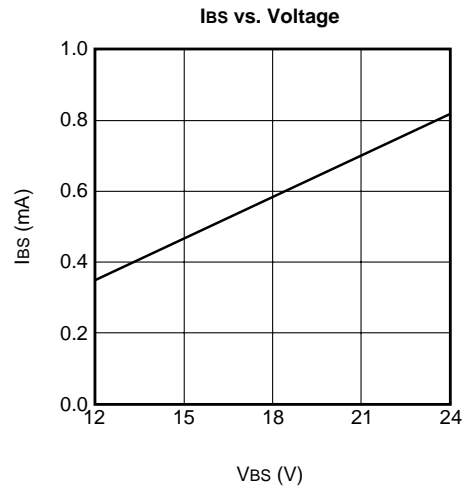
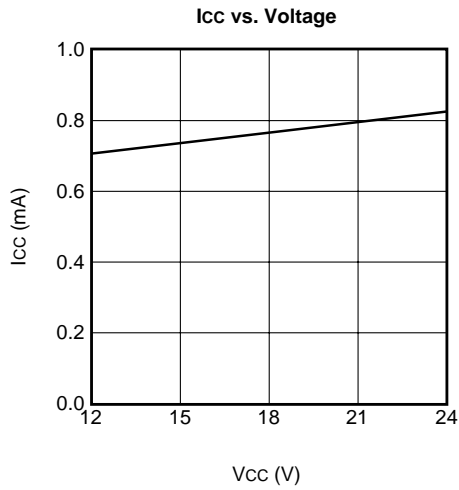

VoH vs. Voltage

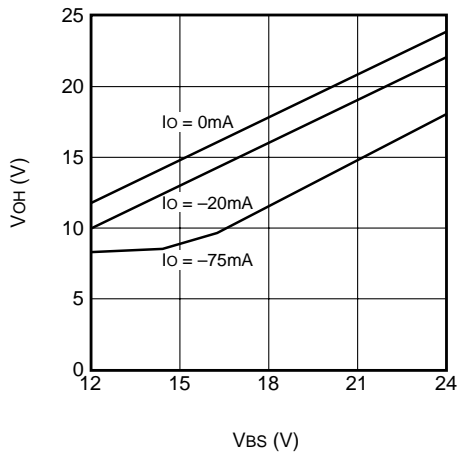

VoL vs. Voltage

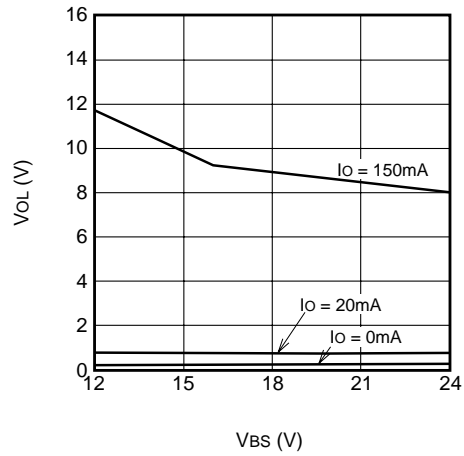

Icc vs. Temperature

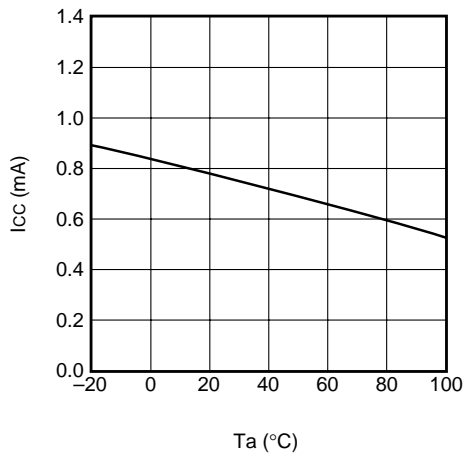

Ibs vs. Temperature

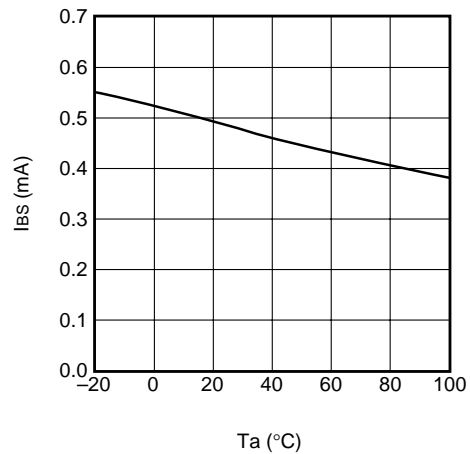

Ifs vs. Temperature

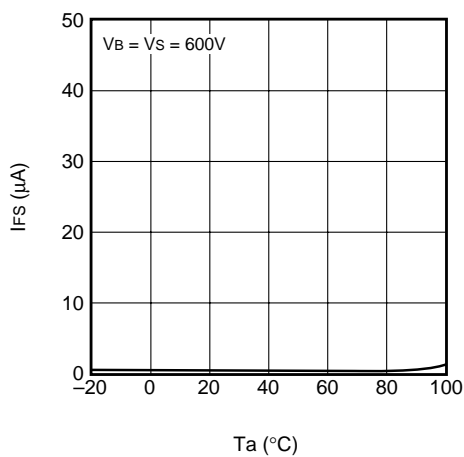

VBSuvr vs. Temperature

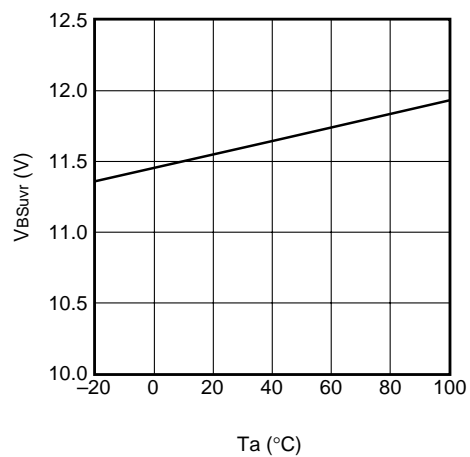

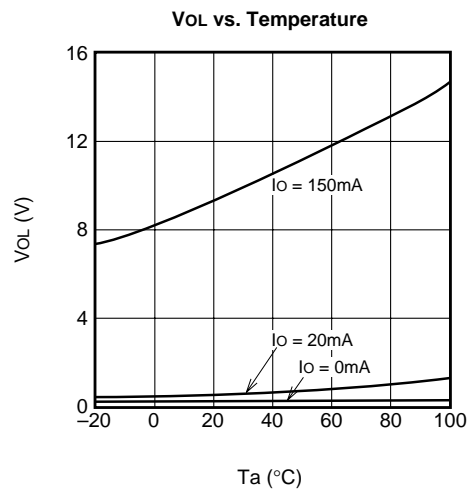
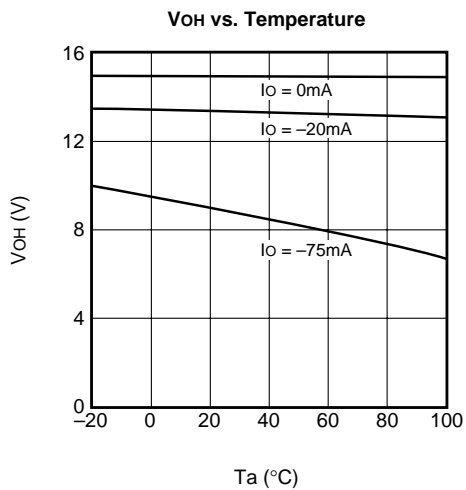
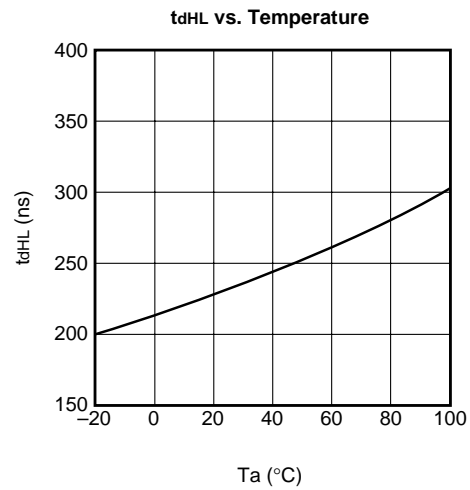
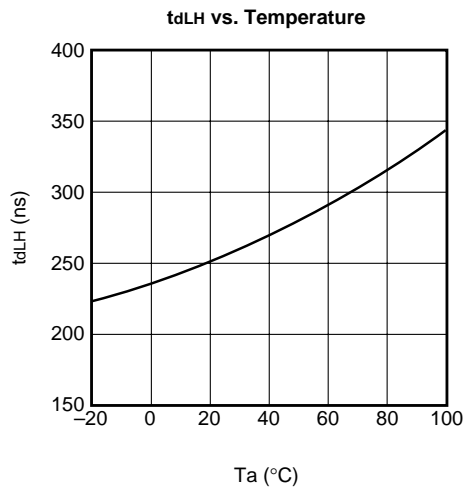
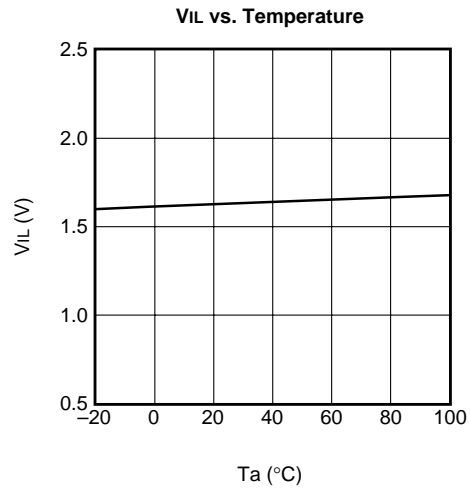
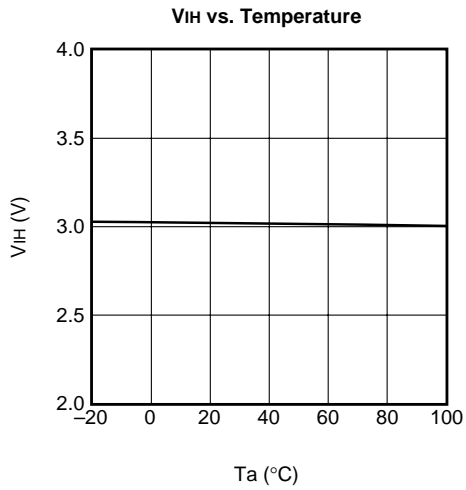

M81705FP

HIGH VOLTAGE HIGH SIDE DRIVER

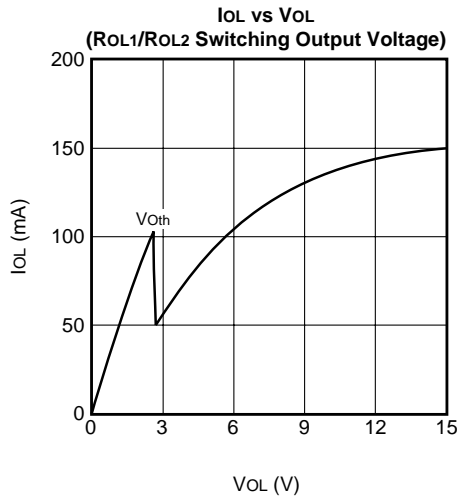

PACKAGE OUTLINE

8P2S-A

EIAJ Package Code SOP8-P-225-1.27	JEDEC Code -	Weight(g) 0.07	Lead Material Cu Alloy
--------------------------------------	-----------------	-------------------	---------------------------

Plastic 8pin 225mil SOP

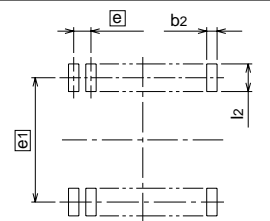
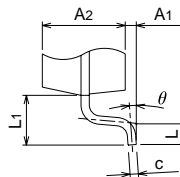
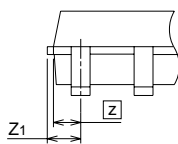
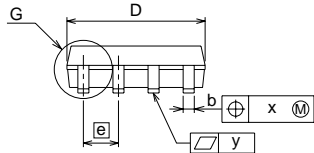
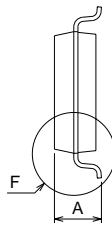
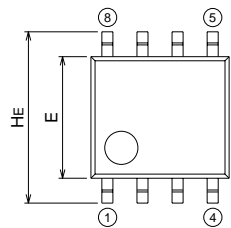

Recommended Mount Pad

Symbol	Dimension in Millimeters		
	Min	Nom	Max
A	-	-	1.9
A1	0.05	-	-
A2	-	1.5	-
b	0.35	0.4	0.5
c	0.13	0.15	0.2
D	4.8	5.0	5.2
E	4.2	4.4	4.6
e	-	1.27	-
HE	5.9	6.2	6.5
L	0.2	0.4	0.6
L1	-	0.9	-
Z	-	0.595	-
Z1	-	-	0.745
x	-	-	0.25
y	-	-	0.1
theta	0°	-	10°
b2	-	0.76	-
e1	-	5.72	-
l2	1.27	-	-